

F.P.JOURNE
Invenit et Fecit

User manual - Quantième Perpétuel

A unique design based on an exclusive mechanism

The Perpetual Calendar

During the 18th century the production of astronomical watches gradually gave way to the manufacturing of watches showing the date and, usually, the moon phases. These primitive calendar watches were all of the simple calendar type, that is to say that at the end of each month of less than 31 days, the days hand had to be put forward manually. It has been a long dream of every watchmaker to add the complicated mechanism of a perpetual calendar to a movement, in which every 4 years, 29 February would be automatically recorded.

A “quantième perpétuel” (perpetual calendar) is a watch that displays the exact date by automatically taking into account the variable length of the months and leap-year cycle. It also displays the day, month and moon phases. To accomplish this feat, the movement must have a mechanical “memory” of 1461 days or four years. The mechanism is usually based on a differential gear system from the hour wheel and includes several hundred components, cogs, gears, levers and rockers. Despite their name, perpetual calendars will have to be corrected by one day on 1 March 2100, not through any fault of the mechanism but due to the Gregorian calendar, which rules that this year, as three centennial years out of four, will not be a leap year.

Although the astronomical year, determined by the Earth revolving around the Sun, has 365.242 days, it is essential that the calendar year has a whole number of days. This results in leap years, introduced by Julius Caesar in 46 BC. Therefore, every four years, the month of February has an extra day.

Taking account of this feature in the date display requires the highest level of watchmaking expertise. Although annual calendar timepieces take account of variations in length of the months, only the perpetual calendar watch is able to give the day, month and date without manual correction, even during leap years. The moon phase display completes this exceptional timepiece.

A movement able to identify leap years has a real mechanical memory. A small toothed planet wheel connected to the months mechanism performs a complete rotation in four years. During the fourth year, this mechanism displays 29 February before directly moving on to 1st March. Just as the moon moves around the Earth, this planet wheel rotates on its own axis resting on a swivel wheel.

This complication, which is both useful and demonstrates technical prowess, is one of the masterpieces of the watchmaking art. However, even if the perpetual calendar watch is perfectly adapted to the Julian calendar, from 1582 our societies gradually adopted the Gregorian calendar in order to correct the slight delay of 0.0078 days per year that remained despite the system of leap years introduced by Julius Caesar, advised by the astronomer Sosigenes of Alexandria. In the Gregorian calendar, named after Pope Gregory XIII, a leap year is omitted every hundred years, except when it is a centennial year whose date is divisible by 400. Thus, 2000 was a leap year and 2400 will be too, while 2100, 2200 and 2300 will not.

François-Paul Journe

Optimum readability and simplified use

for the new F.P. Journe Quantième Perpétuel (perpetual calendar) with instantaneous jump_

The ninth creation of the Octa collection, the new F.P. Journe Quantième Perpétuel with instantaneous jump presents a distinctive aesthetic compared to all existing perpetual calendars in offering perfect readability through on uncluttered dial with large apertures: two for the day and month calendar, and a large date in two windows, a specificity of F.P. Journe watches. The instantaneous jump is reinforced by an ingenious F.P. Journe system designed to accumulate energy and release it instantaneously when the date, day or month changes; and then slow it down at the end of its route.

Unlike perpetual calendars that are often difficult to adjust, the F.P. Journe Quantième Perpétuel is very easy to use. All corrections are made using the three-position crown, except for the rapid correction of months, which is carried out by a protected and hidden corrector lever beneath the lug at 1 o'clock, thus facilitating the adjustment over four years without any specific tool.

The months with 28, 29, 30 and 31 days are automatically taken into account and the leap years are indicated in the center of the dial under the hour and minute hands with years 1, 2 and 3 in black and L for the leap year shown in red.

The automatic winding movement of the Quantième Perpétuel by F.P. Journe Invenit et Fecit is manufactured in 18K rose Gold, like that of all the brand's precision chronometers. It is constructed on the basis of the exclusive Octa calibre 1300.3, with an identical calibre leaving room to insert all the complications of the Octa line.

It also features the exclusive off-centre F.P. Journe rotor in 22K red Gold that offers optimal winding of the watch for an effective power reserve with retrograde indication for over 120 effective hours. It winds the movement in only one direction with an autoblocant ball bearing system (self-blocking). Every infinitesimal movement of the wrist is thus maximally exploited for an optimised winding of the watch.

With a total and very limited production of nearly 900 pieces per year, the custom of F.P. Journe is to stop producing an existing calibre when creating a new model. Therefore, the Quantième Perpétuel replaces the Octa Calendrier with annual calendar, which will cease production in 2015 thus becoming a collector's piece.

The Quantième Perpétuel is available in Platinum or in 18K red Gold, in 40 or 42 mm diameter. The red or white Gold dial is fixed by a steel circle with a silver chapter ring.

Calibre Octa

An Horological Ideal_

The construction of the Octa calibre has less powerful ties with the history of horology as the constant-force device or resonance models do. Nevertheless, it symbolizes a horological ideal: giving timekeepers the highest possible degree of precision and autonomy.

It can be observed, that if church clocks are set so high in towers, apart from enhancing visibility, it was mostly because it often took an entire month for the driving weights to drop the length of their cords. Numerous systems were invented to increase the running time of timekeeper's devices, only meeting limited success. Given the restricted volume of a wristwatch, the size of the mainspring was immediately limited. Watchmakers then discovered the trick of adding an extra wheel to the customary gear train, in order to extend the length of its development. Unfortunately, using this system only led them to observe that the level of energy actually reaching the balance remained poor. To compensate, they fitted a smaller balance consuming less energy, but which also lost in stability. Therefore, it's not unusual to find watches that run for several days displaying an extremely unpredictable level of accuracy.

This challenge was a powerful source of motivation. I then imagined that the best and most obvious solution to lengthen the running time would be to increase the capacity of the spring development. Given its stability (1 metre and 1 millimetre thick), the challenge was to integrate it on the same level as the gear train and escapement. Thanks to the low torque of this spring, I could achieve extremely fast automatic winding (one and a half hour on a Chappuis cyclotest for over 5 day's running).

Once the challenge of autonomy was thus successfully met with this automatic winding calibre, I knuckled down to the second challenge of managing to insert various complications into that same movement: power reserve with large date display, fly-back chronograph with large date display, retrograde annual calendar, UTC and of doing so while maintaining an identical size for all models in the Octa collection.

François-Paul Journe



Octa Calibre

Optimized winding system_

Always taking into account the notes and observations concerning his watches, François-Paul Journe states:

“I realized that one of my friend’s Octa was never completely wound because he works on a computer and his hand doesn’t move enough.”

From this observation he created the new Octa caliber (1300-3) that uses the slightest movement to automatically wind the watch. With talent, the watchmaker turns the problem around, and creates a new off centered rotor heavier in 22K gold, that winds in only one direction with a self-locking ball bearing system. The ceramic balls allow the rotor to move in one direction and block it in the other. This way, every infinitesimal movement is maximally exploited for an optimized winding of the watch.

Mechanism of the Octa Calibre EP Patented System

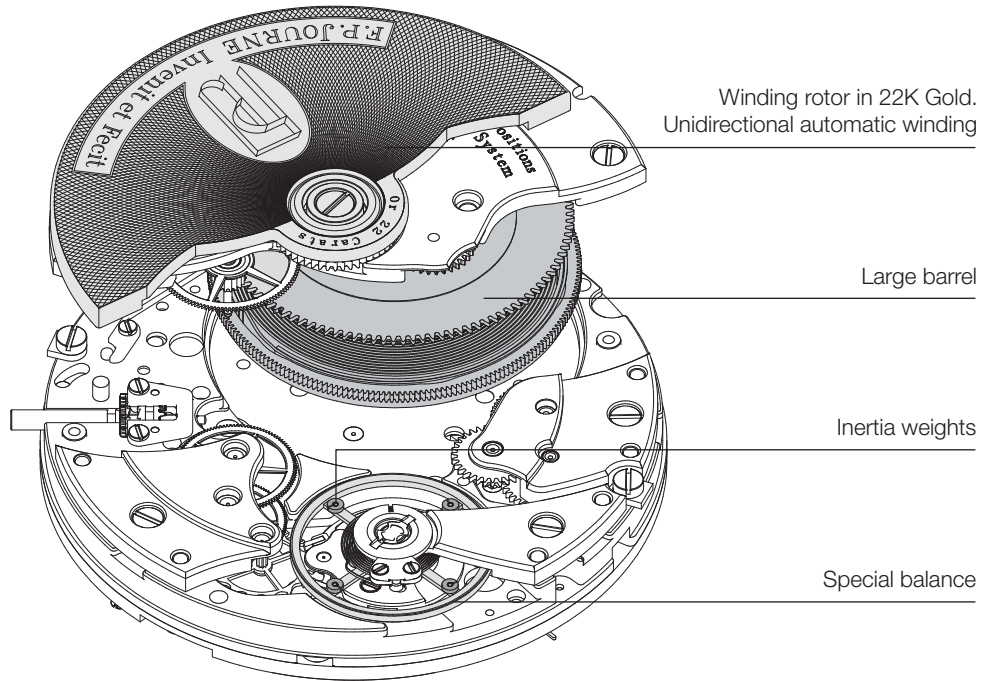

Important!

On a rotating watch winder, for all models of the Octa line, program **274 rotations / 24 hours** to maintain the precision of the watch.

Turn only in the indicated direction!



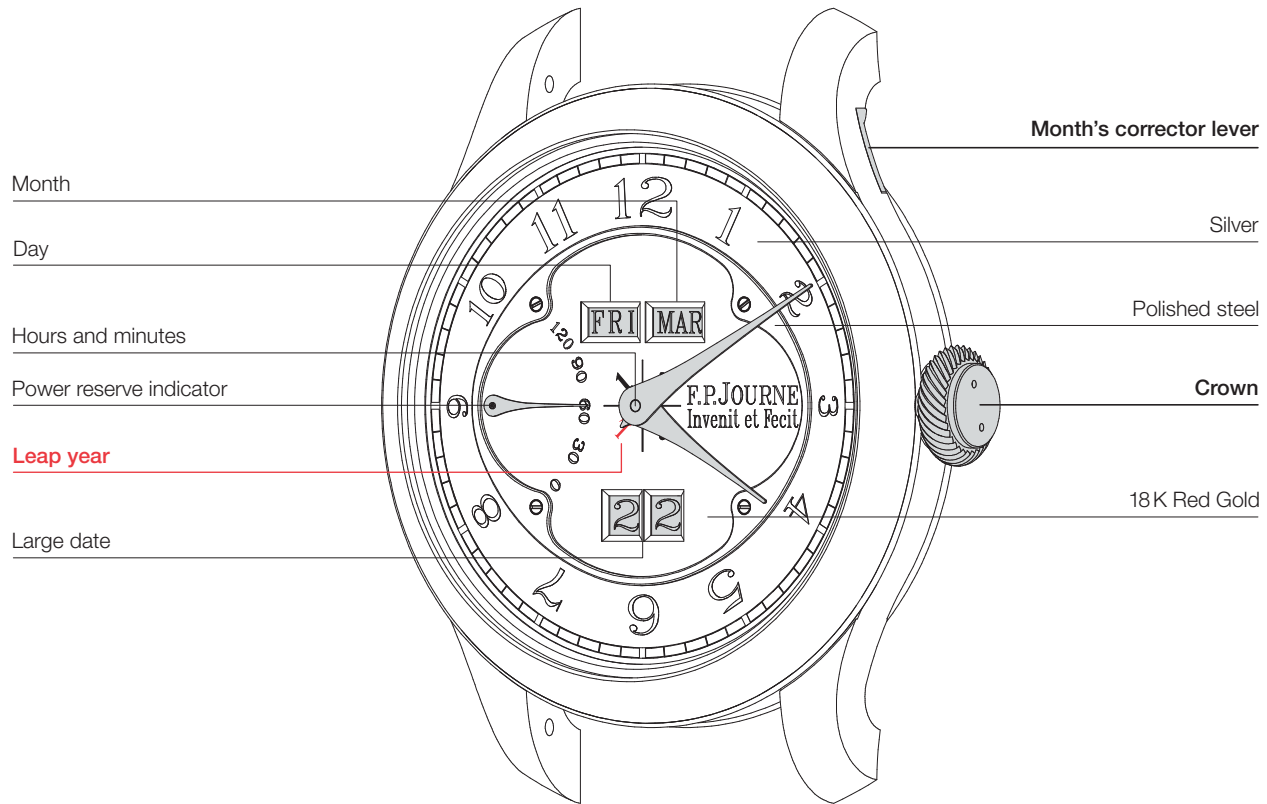

The hours and minutes dial in silver guilloché is fixed by a steel circle screwed* on the 18K Gold dial.

*Patented system

Month's corrector lever_

Setting of the months/years :

0

Corrector lever initial position.

1

Unlock the corrector lever in position **1** for setting.

2

A slight impulse on the lever allows the rapid correction of the month.
Once the correction has been made, put the lever back in its initial position.

Important!

Push the lever back under the lug in position **0** until you hear a small safety click.

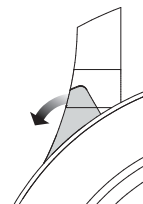

Position 0
Initial

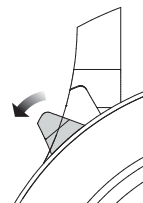

Position 1
Ready for setting

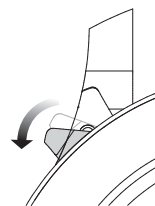

Position 2
Rapid correction

Crown_

Manuel winding:

Your watch is automatically wound when worn.

If the watch is stopped, turn the crown in position **0** about a dozen times clock wise.

Power reserve:

The power reserve hand indicates the number of hours remaining for the watch to function.

All models of the Octa Line offer an exceptional power reserve of 5 days (120 hours+).

The Octa models can operate longer than those 120 hours but the precision is thus not as efficient.

Setting the date:

Pull the crown in position **1** and turn anti clock wise.

Setting the day:

Pull the crown in position **1** and turn clock wise.

Setting the time:

Pull the crown in position **2** and turn anti clock wise to advance the watch hands.

It is strongly advised not to turn the hands in the other direction.

Important!

Push the crown back in position **0** for the watch to work.

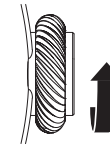

Position 0
Winding

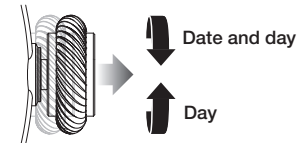

Position 1
Setting

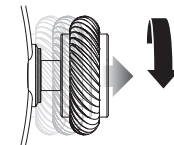

Position 2
Setting the time

Specifications

Movement_

Calibre 1300.3
Unidirectional automatic winding
Movement in 18K rose gold.

Dimensions of the movement_

Overall diameter:	33.00 mm
Casing-up diameter:	30.40 mm
Overall height:	5.20 mm
Height of winding stem:	1.80 mm
Diameter of stem thread:	S0.90 mm

Balance_

Escapement 15 tooth
Chronometric balance with inertia weight
Anachron free-sprung flat balance spring
Mobile stud holder
Free sprung
Nivatronic laser soldered balance spring
Pinned GE stud
Barrel with slipping spring
Off centre winding rotor

Frequency:	21,600 v/h, (3Hz)
Inertia:	10.10 mg*cm ²
Angle of lift:	52°
Amplitude:	12h dial up: > 280° 90h dial up: > 220°

Main characteristics_	<p>Three position crown. Perpetual calendar with instantaneous jump. Simultaneous correction of the date and day in one direction, rotation of the day only in the other direction in position 2 of the winding stem. Discreet corrector in the lug of the watchcase for correction of the month and leap year.</p>	
Indications_	<p>Central hours, minutes and leap year Date, day and month in apertures Power reserve at 9h00</p>	
Autonomy_	<p>160 hours ± 10h. Winding speed on watch winder: 274 rotations / 24 hours</p>	
Decoration_	<p>Cotes de Genève on bridges Partly circular graining on base plate Polished screw heads with chamfered slots Chamfered and circular grained wheels Steel components hand polished and chamfered</p>	
Case_	Platinum or 18K red Gold	
	Diameter :	40 or 42 mm
	Total height :	10.80 mm
Number of parts_	Jewels :	37
	Movement without dial :	340
	Cased up with strap :	374

Maintenance_

A maintenance cleaning is required **every four years** to preserve the precision of the watch.

Important_

Keep the original warranty card supplied with your wristwatch carefully. Your authorized **F.P. JOURNE** retailer will need this identity card for any after-sales servicing. For all maintenance or repair, your wristwatch must be entrusted only to an appointed **F.P. JOURNE** agent.

Warranty_

Your **F.P.Journe - Invenit et Fecit** watch is covered by a warranty against any manufacturing flaws for a period of **2 years** as of the date of purchase appearing on the back of the warranty card or certificate. The warranty is valid only on presentation of the original card or certificate, duly filled out by the authorised retailer (serial number, date of purchase, retailer's stamp). The warranty does not cover normal wear or damage resulting from abnormal use of the watch, accidents or alterations.

Warranty extension_

If your **F.P.Journe - Invenit et Fecit** watch was purchased at an **F.P.Journe Boutique**, your watch is automatically covered for a period of **3 years** as of the date of purchase appearing on the back of the warranty card or certificate. If your watch was purchased at an **authorized retailer**, we kindly invite you to register on <https://customerservice.fpjourne.com/en/guarantee> during the 30 days following the initial date of purchase to benefit from **an additional year of warranty**.